



For after Sales support Contact:
BDS FIRE Shepley House Restmor Way
Hackbridge Surrey SM6 7AH
Tel 020 8773 3377
E: info@bds-fire.co.uk W: www.bds-fire.co.uk



Opal™ AV Devices

Data Sheet



Notifier's Opal AV (Audio Visual) range is designed to alert building occupants of an emergency. The Opal AV range of analogue addressable, loop powered, audible and visual alarm devices, provides a comprehensive selection of products designed to meet the majority of fire alarm installation requirements. The range utilizes Notifier's advanced digital Opal protocol to minimize the current required, enable longer loops and provide distinct signals for different alarm types.

The Opal AV range is easily mounted on the standard Notifier B501AP base for improved installation flexibility making all devices - detectors, sounders and beacons alike - fully interchangeable without the need for any wiring disturbance.

Benefits

- **Faster installation** - The large cable access, rear or surface cable entry options and innovative loop continuity spring all make for faster more cost effective installation.
- **Reduced install errors and easy fault finding** - devices are mounted using a positive push and turn engagement system and are supplied with an address tag for clear identification. Isolation is built-in to each device and addressing is made simple by familiar rotary wheel address controls. In addition each device incorporates an anti-tamper feature giving added security.
- **Excellent system performance** - Light output and a selection of 32 sounder tones can be synchronised via the Notifier control panel to provide fast clear warning of a fire related incident.

- **Flexible installation** - The low current draw of the devices enables more devices on each loop. This combined with the wide range of devices and mounting options including deep bases and IP65 ratings, white or red colour options and sounder volume controllable from the panel or the sounder itself all make for greater flexibility for the system designer.
- **Reduced lifetime costs** - each device in the Opal AV range is constructed from high quality UV stable materials, designed for impact resistance and years of trouble free operation. If changes to a system are required the universal system base means a sounder/beacon can be added without re-wiring.
- **Reduced inventory count** - Notifier's Opal AV range now utilizes the B501AP system base, - common to detectors. The Opal AV range is designed to maximise the features of Notifier's advanced digital Opal protocol but remains backward compatible with previous Notifier communication protocols so can be used for retrofit and replacement for older systems.

Opal AV devices provide both standard wall mounted units and integrated base units allowing the direct fitting of Notifier detectors. Wall mounted units are available as a sounder, a VAD (Visual Alarm Device) only and sounder & VAD combination. Integrated base sounder units are also available as either a sounder, VID (Visual Indicating Device) or a sounder with VID.

This document is not intended to be used for installation purposes. Every care has been taken in the preparation of this document but no liability can be accepted for the use of the information therein. Design features may be changed or amended without prior notice.

For more information, contact:
NOTIFIER, Caburn House, Brooks Road, Lewes, E. Sussex, BN7 2BY
Phone: +44 (0) 1273 897000 Fax: +44 (0) 1273 376894

ISO9001
Design, Manufacture and
Supply to Quality Management
Systems Certified to
ISO9001:1994





For after Sales support Contact:
 BDS FIRE Shepley House Restmor Way
 Hackbridge Surrey SM6 7AH
 Tel 020 8773 3377
 E: info@bds-fire.co.uk W: www.bds-fire.co.uk



Addressable Loop Powered Base Sounder, VID (Visual Indicating Device) & Sounder with VID

Notifier's range of base sounders and sounders with VIDs are high quality loop powered devices designed to alert building occupants of an emergency. Featuring fast and simple installation and control they form the perfect base for Notifier Opal detectors. Powered by the fire panel via the loop wiring, control of the devices is enabled using on-board switches or via the Opal digital protocol using the control panel. The range is installed simply by a twist fit onto the B501AP base which is used for detectors.

The Opal base sounder with VID integrates a high quality 32 tone sounder and high quality VID into one unit. When triggered by the fire panel its powerful sounder gives an audible warning whilst the VID provides additional indication.

The Opal base sounder is a high quality 32 tone sounder. A choice of output levels and tones make the device suitable for a wide variety of applications.



Specifications

Opal Addressable Base Sounder - NFXI-BS-W

Opal Addressable Base Sounder/VID - NFXI-BSF-WC

Opal Addressable Base VID - NFXI-BF-WC

Mechanical Specification

	NFXI-BS-W	NFXI-BSF-WC	NFXI-BF-WC
Height:	64mm	64mm	64mm
Diameter:	121mm	121mm	121mm
Weight:	200g	202g	200g
Body colour:		white*	
Lens colour:	N/A	Clear	Clear
Light colour:	N/A	Red	Red
Beacon flash rate:	N/A	1Hz	1Hz
Number of tones:	32	32	N/A
Volume settings:	High, Medium & Low		N/A
Wire gauge for terminals:	1.5 - 2.5mm ² max		

Electrical Specification

	NFXI-BS-W	NFXI-BSF-WC	NFXI-BF-WC
Supply voltage:	15 to 28VDC		
Standby current:	450µA (CLIP) 320µA (Opal)		
Max current consumption:	<10.5mA ¹	< 14mA ¹	< 3.5mA
Max sound output:	95dB(A) +/-3dB @1 metre ²		N/A

¹ High Volume Tone 21 @24V

² High Volume, Tone 8 @24V (Tone Dependent - Figure stated is based on high volume 970Hz continuous @24VDC)

Environmental Specifications

- Temperature Range: -25°C to +70°C†
- Humidity: Max. 95% relative humidity (non-condensing)
- IP Rating: IP24 with low profile (B501AP) base
IP44 with deep bases (BRR, BPW, BDD)
IP65 for NFXI-BS with sealed deep base (WRR)

Approvals

- Approved to: EN54-3, EN54-17 and CPD

NFXI-BSF-WC & NFXI-BF-WC - This product is not approved to EN54-23 (Visual Alarm Device) and must not be used as a visual alarm device to provide a primary warning notification of fire.

*Also available in ivory colour to match previous ranges of detectors.
 NFXI-BS-IV and NFXI-BSF-IVC - electrical and mechanical specifications are otherwise the same.

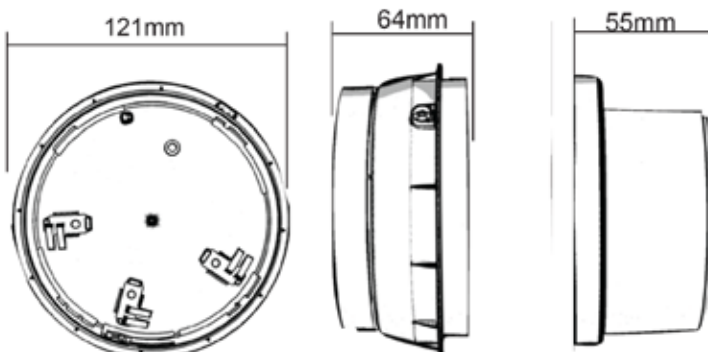



For after Sales support Contact:
 BDS FIRE Shepley House Restmor Way
 Hackbridge Surrey SM6 7AH
 Tel 020 8773 3377
 E: info@bds-fire.co.uk W: www.bds-fire.co.uk



Addressable Loop Powered Wall Mount Sounder, VID & VAD

Notifier's range of wall mount sounders and beacons are high quality loop powered devices designed to alert building occupants of an emergency. Featuring fast and simple installation and control they are powered by the fire panel via the loop wiring. Control of the devices is enabled using on-board switches or via the Opal digital protocol using the control panel. The range is installed simply by a twist fit onto the B501AP base.

The Opal wall mount sounder/VAD integrates a high quality 32 tone sounder and high quality beacon into one unit. When triggered by the fire panel its powerful sounder and intense beacon give a visible and audible warning.

The Opal wall mount sounder is a high quality 32 tone sounder. A choice of output levels and tones make the device suitable for a wide variety of applications.

The Opal wall mount VAD is a high quality loop powered device which when triggered by the fire panel emits an intense light to give a visible warning to building occupants.



Specifications

Opal Addressable Wall VAD - NFXI-WF-WC
 Opal Addressable Wall Sounder - NFXI-WS-R
 Opal Addressable Wall Sounder/VAD - NFXI-WSF-WC

Mechanical Specification

	NFXI-WF-WC	NFXI-WS-R	NFXI-WSF-WC
Height:	51mm	64mm	64mm
Diameter:	121mm	121mm	121mm
Weight:	238g	168g	238g
Body colour*:	N/A	Red	N/A
Lens colour*:	Clear	N/A	Clear
Light colour:	Red	N/A	Red
Beacon flash rate:	1Hz	N/A	1Hz
Number of tones:	N/A	32	32
Volume settings:	N/A	High, Medium & Low	
Wire gauge for terminals:	1.5 - 2.5mm ² max		

Electrical Specification

	NFXI-WF-WC	NFXI-WS-R	NFXI-WSF-WC
Supply voltage:	15 to 28VDC		
Standby current:	450µA (CLIP) 320µA (Opal)		
Max current consumption:	3.5mA	11.4mA ¹	14.7mA ¹
Max sound output:	N/A	97dB(A) +/-3dB @1metre ²	

¹ High Volume Tone 21 @24V

² High Volume, Tone 8 @24V (Tone Dependent - Figure stated is based on high volume 970Hz continuous @24VDC)

Environmental Specifications

- Temperature Range: -25°C to +70°C[†]
- Humidity: Max. 95% relative humidity (non-condensing)
- IP Rating: IP24 with low profile (B501AP) base
IP44 with deep bases (BRR, BPW, BDD)
IP65 for NFXI-BS with sealed deep base (WRR)





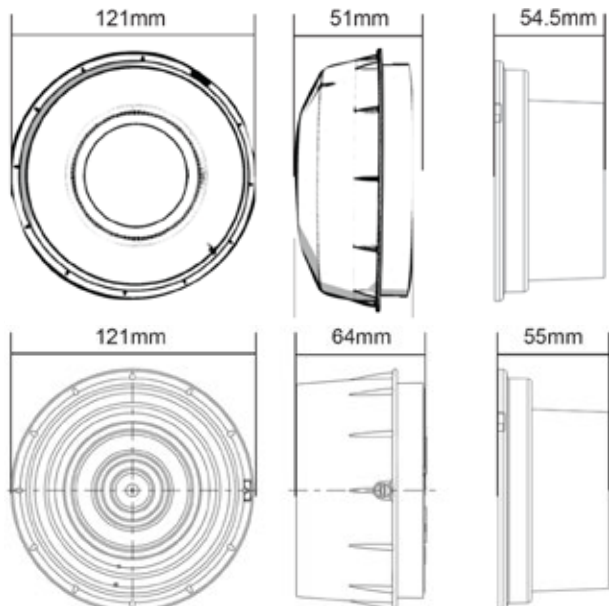









Approvals

- Approved to: EN54-3, EN54-17 and CPD
- NFXI-WF-WC Approved to EN54-23 O class (W-1.68-1.68)
- NFXI-WSF-WC Approved to EN54-23 O class (W-1.9-1.9)
- NFXI-WSF-WC Approved to EN54-3. Not approved to EN54-23 (Visual Alarm Device) and must not be used as a visual alarm device to provide a primary warning notification of fire.



*Sounders are also available with white body NFXI-WS-W - electrical and mechanical specifications are otherwise the same.

Product Range at a Glance

Opal AV Devices (White)		Part Number
	Base Sounder - Addressable loop powered base sounder, EN54-3 approved. WHITE. Built in loop isolation.	NFXI-BS-W
	Base VID - Addressable loop powered visual indicating device (VID). White body, clear lens with red flash. Built in loop isolation. This product is not approved to EN54-23 (Visual Alarm Device) and must not be used as a visual alarm device to provide a primary warning notification of fire.	NFXI-BF-WC
	Base Sounder VID - Addressable loop powered base sounder, EN54-3 approved, with visual indicating device (VID). White body, clear lens with red flash. Built in loop isolation. This product is not approved to EN54-23 (Visual Alarm Device) and must not be used as a visual alarm device to provide a primary warning notification of fire.	NFXI-BSF-WC
	Wall Sounder - Addressable wall mounted loop powered sounder, EN54-3 approved. RED. Built in loop isolation.	NFXI-WS-R
	Wall Sounder - Wall mounted, addressable, loop powered sounder, EN54-3 approved, WHITE, with built in loop isolation	NFXI-WS-W
	Wall Sounder VID - Wall mounted, addressable, loop powered sounder, EN54-3 approved, with visual indicating device (VID), RED lens. Built in loop isolation. This product is not approved to EN54-23 (Visual Alarm Device) and must not be used as a visual alarm device to provide a primary warning notification of fire.	NFXI-WSF-RR
	Wall Sounder VAD - Wall mounted, addressable, loop powered sounder, EN54-3 approved, with Visual Alarm Device (VAD), EN54-23 O class compliant (W-1.9-1.9). Clear lens with red flash. Built in loop isolation.	NFXI-WSF-WC
	Wall VAD - Wall mounted, addressable loop powered EN54-23 O class compliant (W-1.68-1.68) clear lens with red flash. Built in loop isolation.	NFXI-WF-WC
	Base - Addressable base for detector and AV - concealed when AV unit installed, use for all colours	B501AP
	Deep Base - Addressable deep base for detector and AV, RED (including B501AP base)	BRR
	Deep Base - Addressable deep base for detector and AV, WHITE (including B501AP base)	BPW
	Deep Sealed Base - Addressable sealed deep base for detector and AV, RED (including B501AP base)	WRR
Opal AV Devices (Ivory)		Part Number
	Base Sounder - Addressable loop powered base sounder, EN54-3 approved. IVORY. Built in loop isolation.	NFXI-BS-IV
	Base VID - Addressable loop powered base sounder, EN54-3 approved, with visual indicating device (VID). IVORY body, clear lens with red flash. Built in loop isolation. This product is not approved to EN54-23 (Visual Alarm Device) and must not be used as a visual alarm device to provide a primary warning notification of fire.	NFXI-BSF-IVC
	Deep Base - Addressable deep base for detector and AV, IVORY	BDD



For after Sales support Contact:
 BDS FIRE Shepley House Restmor Way
 Hackbridge Surrey SM6 7AH
 Tel 020 8773 3377
 E: info@bds-fire.co.uk W: www.bds-fire.co.uk



Caburn House | T: +44 (0) 116 246 2255
 Brooks Road | F: +44 (0) 116 246 2210
 Lewes, E. Sussex, | E: sales@notifierfiresystems.co.uk
 BN7 2BY, UK | www.notifierfiresystems.co.uk